



## LANTERNA 477

Laudani & Romanelli  
1998

Suspension lamp giving diffused light. Transparent and sand-blasted Murano glass diffusers. Glazed anodized metal structure.

### DIMENSIONS

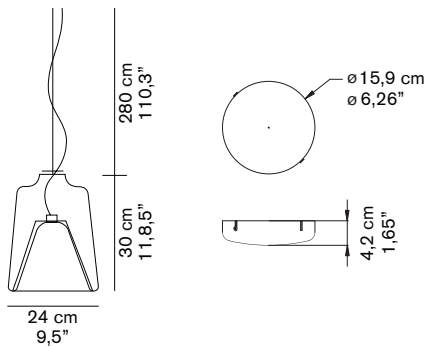

### MATERIALS

blown glass

### COLORS

transparent - sand blasted

### BULBS

1x max 100 W - E26



equipped without bulb

Note: lamp compatible with LED bulbs (according to the market availability and without changes to the standard product)

### MARKS



### FURTHER INFORMATION



white rose



transparent cable



accessory: multiple ceiling plate/square

### PACKAGING



dimensions 32x32x61 cm / 12,6"x12,6"x24"  
volume 0,0624 m<sup>3</sup> / 2,20 ft<sup>3</sup>  
weight 6 kg / 13,22 lb

### TYPE

indoor - suspension lamp

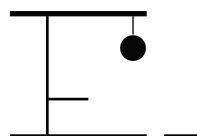

### PHOTOMETRIC CURVE

